

M318F

Wheeled Excavator

2017



Engine

Engine Model	Cat® C7.1 ACERT™	
Emissions	U.S. EPA Tier 4 Final, EU Stage IV	
Net Power (maximum)		
ISO 9249/SAE J1349 at 1,750 rpm	126 kW	169 hp
ISO 9249/SAE J1349 at 1,750 rpm, metric		171 hp
ISO 14396 at 1,750 rpm (gross)	129.4 kW	174 hp
ISO 14396 at 1,750 rpm (gross), metric		176 hp

Weights

Operating Weight with Attachment	17 930 kg-	39,529 lb-
	19 270 kg	42,483 lb

Bucket Specifications

Bucket Capacities	0.35 m ³ -	0.46 yd ³ -
	1.09 m ³	1.43 yd ³

Working Ranges

Maximum Reach at Ground Level	9405 mm	30'10"
Maximum Digging Depth	6090 mm	20'0"

Drive

Maximum Travel Speed	35 kph	22 mph
----------------------	--------	--------

M318F Features

Made to keep your costs down.

Not only does the machine give you all the versatility you need, but it does so while providing a great deal of precision, and speed with an absolute minimum fuel consumption – and zero impact on your efficiency.

Made to make operation easy and pleasant.

Have a seat, you will be impressed by the quietness and comfort of the cab. Feel relaxed, we help you make sure you're safe.

Enjoy integrated technologies; they act transparently.

When you add the ground level grouped service points that make your maintenance quick and easy, and multiple Cat attachments that help you do all kinds of jobs, you simply won't find a better machine.

Contents

Sustainability	4
Engine	5
Built-in Fuel Savers That Add Up	5
Premium Comfort	6
Simplicity and Functionality	7
The Next Generation	8
Smart Technologies	9
Dig and Go Auto Axle Lock.....	9
Hydraulics	10
Undercarriage	11
Booms and Sticks	12
SmartBoom™.....	13
Ride Control.....	13
Attachments.....	14
Serviceability	16
Integrated Technologies	17
Safety	18
Unmatched Visibility.....	20
Complete Customer Care.....	20
Specifications.....	21
Standard Equipment.....	31
Optional Equipment.....	33
Notes.....	34





The new F Series generation is here to help you take on the wide variety of challenges you face every day, more easily and at a lower cost.

F Series Wheeled Excavators – Easier Than Ever.



Sustainability

Generations Ahead in Every Way

Fuel Efficiency and Reduced Exhaust Emissions

The engine meets Tier 4 Final/Stage IV emission standards, is powerful and efficient, with an optimized 10% fuel consumption improvement versus the previous model and no impact on your productivity. This means less resource consumption and fewer CO₂ emissions.

Quiet Operation

Outstandingly low sound levels, you won't believe your machine is running.

Transparent Technologies and Longer Service Intervals

- The Eco Mode, Auto Engine Speed Control and Engine Idle Shutdown help further reduce your overall fuel consumption.
- Product Link™ allows remote monitoring of the machine and helps improve overall efficiency.
- Your Cat dealer can help extend service intervals, meaning fewer fluids and disposals, all adding up to lower costs.

Biodiesel and Biodegradable Hydraulic Oil

- The M318F has the flexibility of running on either ultra-low-sulfur diesel (ULSD) fuel with 15 ppm of sulfur or less or up to B20 biodiesel fuel blended with ULSD.
- Cat BIO HYDO™ Advanced HEES™ reduces the impact on the environment.

Cat Certified Used

This program is a key element in the range of solutions offered by Caterpillar and Cat dealers to help customers achieve growth at the lowest cost while eliminating waste. Used equipment is inspected, guaranteed and ready for work and customers will benefit from a Caterpillar warranty.

Engine

Power, Reliability, and Fuel Economy



The Power and Performance You Need

Constant Power Strategy

Provides a quick response to changing loads, while delivering the same amount of power regardless of operating conditions.

A Transparent Emission Solution That Works.

The Cat C7.1 ACERT engine meets today's Tier 4 Final/Stage IV emission standards, and it does so without interrupting your job process. It is designed to be:

- **Transparent:** no operator intervention
- **Durable:** fit for life Diesel Particulate Filter
- **Efficient:** no work interruption, even in case of extended idling time
- **Simple:** minimum maintenance. Longitudinal engine installation, which further simplifies maintenance.

Biodiesel Not a Problem

The engine can run on up to B20 biodiesel fuel that meets ASTM 6751 standards – all to give you more potential fuel-saving flexibility.

Proven Technology

To assure that our technology will meet your expectations for reliable trouble-free service, we subjected these engines and technologies to extensive operating hours of test and validation.

Built-in Fuel Savers That Add Up

- **Automatic Engine Speed Control:** lowers engine speed when it is not needed.
- **Engine Idle Shutdown:** turns the engine off when it's been idling for more than a pre-set amount of time.
- **On-Demand Cooling System:** variable speed and on-demand fan.
- **Enhanced Eco Mode:** reduces engine speed while delivering the same power.
- **Automatic Shift to Travel Mode** when you start driving.
- **NEW! Optimized Travel Mode:** travel mode rpm levels are set automatically on-demand only to further reduce fuel consumption.

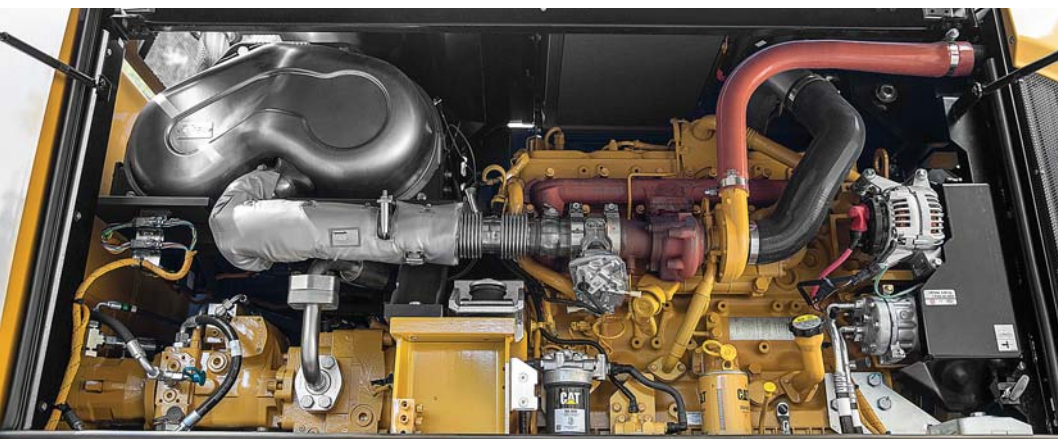

Premium Comfort

Keeps Operators Productive All Shift Long



Legacy from the Renowned Cat Wheeled Excavators

Designed for the operator, our cabs are unique.

Ergonomic Layout

- Frequently used switches are centralized, kept to the minimum and ideally located close to the joysticks.
- Storage compartments are useful... when well designed. Several areas provide sufficient room to store a hard hat, a drink, phone, or keys.

Comfortable Seat Options

Our seats provide all the comfort needed for a long day of work, including FULL adjustment. All seats are heated and air suspended. Automatic weight adjustment and air ventilated seats are available.

Safety Is Not Optional

ROPS cab, compatible with FOPS, seat belt alarm, safety bar, sideview camera ... among others.

Details That Make the Difference

Have a look at the cab; you will see it is through details that we improve pleasure of operating.

Smart Controls to Reduce Fatigue

- Features like ride control, SmartBoom or Joystick Steering will be precious to increase your productivity.
- New technologies that work transparently like the swing and auto travel lock or the automatic brake and axle lock, reduce the number of tasks you need to do.

Plug, Charge and Play Your Devices

- The 12V 10A power supply socket is conveniently located for charging your laptop, or a tablet.
- A CD/MP3 Radio with speakers and USB port is available.





Simplicity and Functionality

For Ease of Operation

A Cab Just for You – Fully Adjustable

- Seat armrests, in height and angle
- Steering column adjustment, not only tilting fore/aft but also in height
- Hydraulic sensitivity of the machine to make it more or less aggressive
- NEW! Joystick and left pedal controls assignments: can be set up as desired and per tool
- NEW! Optional advanced joystick offering more controls (two sliders, five buttons each)
- Automatic air conditioning
- NEW! Optional heated mirrors are now also electrically adjustable from the cab

Incredibly Low Sound Levels, Less Fatigue

Increased cab pressure, preventing from dust entry, combined with the cab design contributes to reducing sound.

Outstanding Visibility: See the Difference!

- All glass areas have been drastically increased
- Standard LED working lights and halogen roading lights
- LED dome light
- Standard rearview AND sideview wide angle cameras
- Wide angle mirrors for better visibility even down to the ground
- Parallel intermittent (four speeds) wipers covering the whole windshield

NEW! Standard LED Lights for BOTH Cameras to See What's Going on Around, Day or Night

The rear camera is integrated into the counterweight for enhanced protection.

NEW! Split-Screen View of BOTH Cameras on the Same Monitor

The views from both cameras are displayed side by side on the additional wide color monitor for better visibility at first glance.

Large Color Machine Monitor

Easy to read and in local language, the high resolution LCD monitor will keep you aware of any important information. "Quick Access" buttons allow a quick selection of favorite functions. The tool select function lets you preset up to ten different hydraulic attachments for quick tool changes.

The Next Generation

Easier Than Ever



Make the Move to the Next Generation

Refinements. From the whole design to the smallest details. Convenient features, new advanced and transparent technologies, not only to reduce emissions but to further improve your daily experience when working with our products.

Cruise Control – Focus on the Road, Not on Your Foot

No need to press the pedal all the time.

- Choose the very speed you wish
- Press the quick access button on the monitor
- Enjoy the ride

It's as Easy as That.

NEW! Trailer-Ready Package* – Hitch-Up Your Trailer and Go

How to be more autonomous than ever while increasing your flexibility?

Our trailer-ready package includes all the necessary electrical and hydraulic systems, even for trailers equipped with a tailgate and dumping devices.

Moving your tools, and fuel along with you to each job site or material directly on site has never been easier!

**Not available for Australia and New Zealand.*



Smart Technologies

Swing and Auto Travel Lock: Press, Go and Relax

No need for the operator to bend to engage the swing lock pin.

- Just press a button,
- Align the upper to the lower frame,
- Enjoy the ride: a green indicator confirms the swing and the implements have been automatically locked.
- NEW! The swing lock can be applied independently from the implements lock at low speed (below 5 kph/3.1 mph)

It's as Easy as That.

Integrated Pin Code – Switch Off and Relax

No need to buy an optional security system to protect your equipment against theft.

- The pin code is integrated into the monitor (standard)
- Entering the right code allows the engine to start

The Machine Security System (MSS – optional) adds even more protection when needed.

It's as Easy as That.



Dig and Go Auto Axle Lock

Presses the pedal for you, reducing the number of actions you need to do

The machine automatically detects when the service brake and axle need to be locked (like when digging), or unlocked (roading), hence removing the need for the operator to systematically press the pedal.

Brake and axle are released automatically by pressing the travel pedal again.



Hydraulics

Fast, Precise, Flexible

When it comes to moving material quickly, you need efficient hydraulics – the type the F Series can deliver.

Efficient Design, Smart and Fast

- **Simple Design:** The hydraulic valve compartment and routings offer a simple and clean design to help ensure durability.
- **Smart Main Hydraulics:** The system allows reducing the load on the engine when not needed, which translates into lower fuel consumption.
- **Dedicated Swing Pump:** A closed hydraulic circuit is dedicated to the swing only. Having two separate pumps, one for the swing and the second for the other functions allows faster and smoother combined movements.

Control Like No Other

- **Electronic Pump Control** – Controllability is one of the main attributes of Cat excavators, and one of the key contributors to this is the Electronic Pump Control (EPC) that's designed to improve response time and precision. It puts flow exactly where you need it, when you need it, which means a much smoother operation and greater efficiency.
- **Adjustable Hydraulic Sensitivity** – Allows you to adjust the aggressiveness of the machine according to the application.
- **Stick Regeneration Circuit** – Increases efficiency and helps enhance controllability for higher productivity.

Proportional Auxiliary Hydraulics, Tremendous Versatility

Medium, high pressure and hydraulic quick coupler lines and circuits: they all come standard.

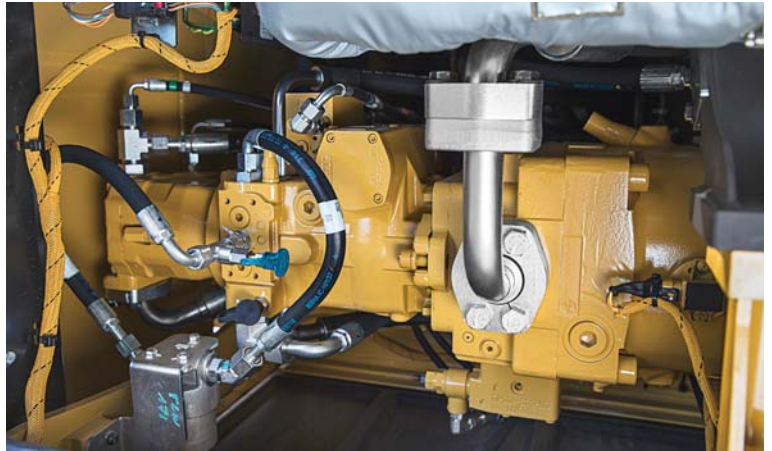

Undercarriage

Strength and Versatility at 35 kph (22 mph)



Heavy Duty Axles

Long life with effective heavy duty axles. The transmission is mounted directly on the rear axle for protection and optimum ground clearance. The front axle offers wide oscillating and steering angles. The drive shaft offers longer service intervals (1,000 hours).

Advanced Disc Brake System

Minimizes the rocking effect when working free on wheels. The disc brake system acts directly on the hub instead of the drive shaft to avoid planetary gear backlash.



Fenders (optional)

Fenders provide excellent coverage of all tires, protecting the machine and surroundings from mud and stones being thrown up.



Joystick Steering

Keep both hands on the joysticks even when simultaneously moving the implements and repositioning the machine, by the use of the slider switch on the right joystick.

Blade Design

- Optimized design to provide rigidity, stability and ease of maintenance.
- Parallel kinematic to keep the blade parallel to the ground, in every height position
- A profile that allows material to roll better and minimizes material packing

Booms and Sticks

Options To Take on Your Far-reaching or Up-close Tasks

Rugged Performance

Booms and sticks are welded, box section structures with thick, multi-plate fabrications in high stress areas for the tough work you do.

Flexibility

The choice of various booms and sticks provides the right balance of reach and digging forces for all applications.

Sticks

- **Medium stick – 2400 mm (7'10")** for greater crowd force and lift capacity
- **Long stick – 2600 mm (8'6")** for greater depth and reach

Booms

- **Variable Adjustable (VA)** – improved right side visibility and roading balance. When working in tight quarters or lifting heavy loads, the VA boom offers the best flexibility.
- **One-Piece Boom** – Fits best for all standard applications such as truck loading and digging. A unique straight section in the curve of the side plate reduces stress flow and helps increase boom life.



SmartBoom

Reduces Stress and Vibration

Rock Scraping

Scraping rock and finishing work is easy and fast. SmartBoom simplifies the task and allows more focus on stick and bucket, while the boom freely goes up and down without using pump flow.

Hammer Work

The front parts automatically follow the hammer while penetrating the rock. Blank shots or excessive force on the hammer are avoided resulting in longer life for the hammer and the machine. Similar advantages with vibratory plate compactors.

Truck Loading

Loading trucks from a bench is more productive and fuel efficient as the return cycle is reduced while the boom down function does not require pump flow.

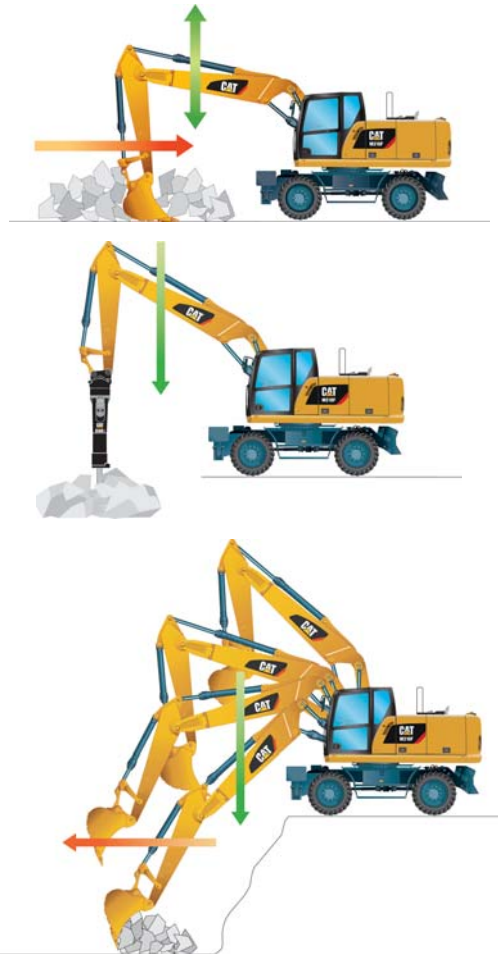

Ride Control

Fast Travel Speed with More Comfort

The ride control system lets you travel faster over rough terrain with improved ride quality for the operator. Accumulators are acting as shock absorbers to dampen the front part motion. It can be activated through a button located on the soft switch panel in the cab.



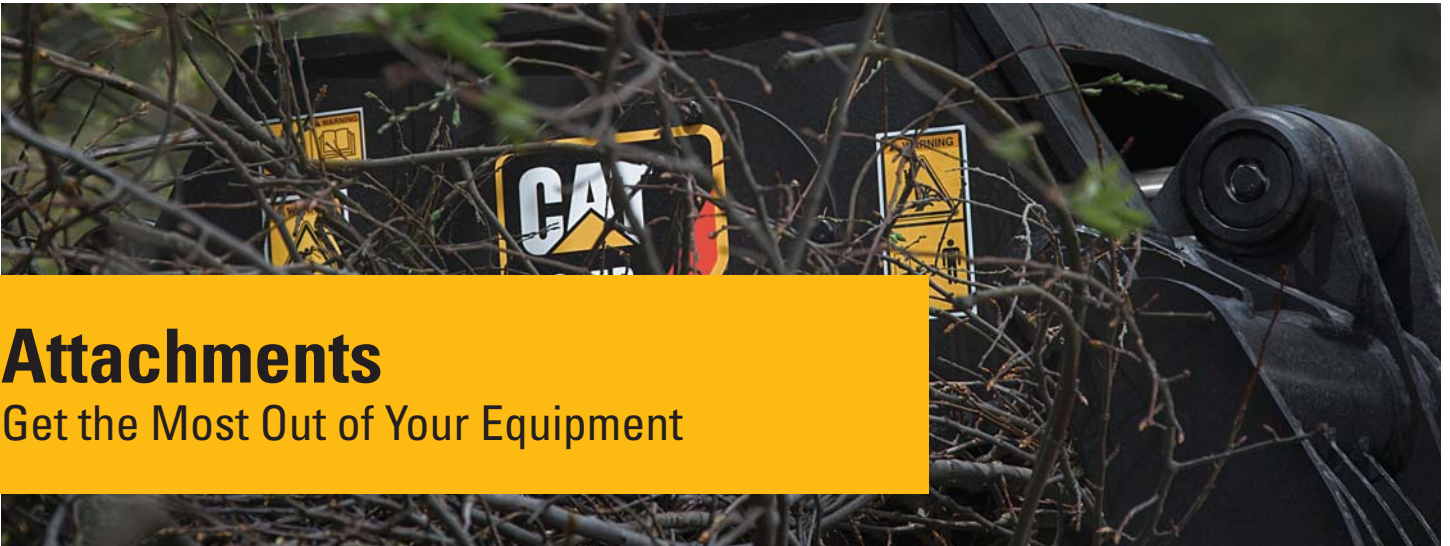

Attachments

Get the Most Out of Your Equipment

NEW! Tilt-Rotator-Ready Option

This option provides a factory-installed on-board platform for a Rototilt® tiltrotator.

Tiltrotators eliminate the need to constantly reposition the machine, by providing a tilting and rotary connection with any attachment.

The wheeled excavator Tilt-Rotator-Ready Package includes all that you need, with lines, circuits, software and advanced joysticks. This is a perfectly integrated interface between the machine and this tool.

Tiltrotator parameters can be set directly from the machine monitor.



Save Time with Tool Changes

Job Site Confidence ... From the operator's seat, visual and audible indicators help assure that the attachment is coupled. Your Cat excavator hydraulics, mechanisms inside the coupler, and digging forces all work together to assure the attachment stays engaged. The Cat Pin Grabber coupler is the secure way to decrease downtime by allowing quick attachment change, and increase job site flexibility.



Power Match

Match your Cat hydraulic attachments to your Cat machine, and get the most out of the standard, built-in software. Attachment changes have never been easier!

Get the Most from Your Machine

If you have multiple tasks to get done, the M318F can help. And you can easily expand all the possibilities it offers by utilizing any of the variety of Cat attachments.

Dig, Load, Finish and Compact

A wide range of buckets offers solutions for digging, trenching, loading and finishing works. The addition of a Cat Compactor will introduce your machine to utility work, site prep, road repair and pipeline work.



Move and Handle Material

Choose from one of three different thumb styles to work with your bucket and you have the instant ability to move and handle brush, rocks and debris.

Demolish and Break

Our hammer includes a buffer to improve your comfort and protect your machine from vibration. Fully enclosed, it is ideal when working in noise regulated areas.



Sort and Load

Demolition and Sorting Grapples bring your machine into demolition and waste handling opportunities. Jaws open wide to move volumes, yet are nimble enough to pull a single copper wire out of a pile. Their 360° rotation capability allows you to place the grapple where you want it without moving the machine.

Scrap and Recycle

Shears also have the ability to rotate 360°. A pulverizer allows you to crush and reduce concrete.

Serviceability

When Uptime Counts

Convenient Access Built In

You can reach routine maintenance items like fuel and engine oil filters and fluid taps at ground level while fuel and DEF tank with engine air filter are accessible from the safety of the slip-resistant new service platform. Compartments feature wide composite service doors, designed to be more resistant to shocks, which all include gas struts to facilitate the opening. Components are now gathered in specific dedicated compartments, like the special electrical compartments.

A Smart Design for Any Temperature

The side-by-side coolers and axial fan design allows greater cooling performance. The system is completely separated from the engine compartment to reduce noise and heat and all radiators are gathered in the same compartment while featuring easy-to-clean cores with a tilting device that requires no tool to unlock.

A Fresh Idea

Ventilation inside the cab allows outside air to enter through a fresh air filter. The filter is located on the side of the cab to make it easy to reach, and it is protected by a lockable door that can be opened with the ignition key.

Lube and Fuel Standard Features

An electric lubricator system is an available time-saving standard feature for greasing the whole upper carriage. Greasing points for the undercarriage are kept to a minimum and grouped. The new drive shaft extends greasing intervals from 500 hours to 1,000 hours and allows simultaneous greasing with the lower axle bearing. An electric refueling pump is also standard. The hose is stored in a dedicated tray, for more cleanliness. Add in the electric lift pump removing the need to prime the system manually, the standard fuel and water separator and you get a machine that does the fastidious maintenance works for you.

Keep it simple.



Integrated Technologies

It Pays to Know



Cat Connect makes smart use of technology and services to improve your job site efficiency. Using the data from technology-equipped machines, you'll get more information and insight into your equipment and operations than ever before.

Cat Connect technologies offer improvements in these key areas:



EQUIPMENT MANAGEMENT

Equipment Management – increase uptime and reduce operating costs.



PRODUCTIVITY

Productivity – monitor production and manage job site efficiency.



SAFETY

Safety – enhance job site awareness to keep your people and equipment safe.

Featured Cat Connect technologies include the following:

Link

Link technologies provide wireless capability to machines to enable two-way transfer of information collected by on-board sensors, control modules, and other Cat Connect technologies.

Manage Your Machine Remotely

Cat Product Link is a system that is deeply integrated into the machine monitoring system to take the guesswork out of managing your equipment. The system tracks location, hours, fuel usage, productivity, idle time, and diagnostic codes and shares it with you through VisionLink® to help you maximize efficiency, improve productivity, and lower operating costs.

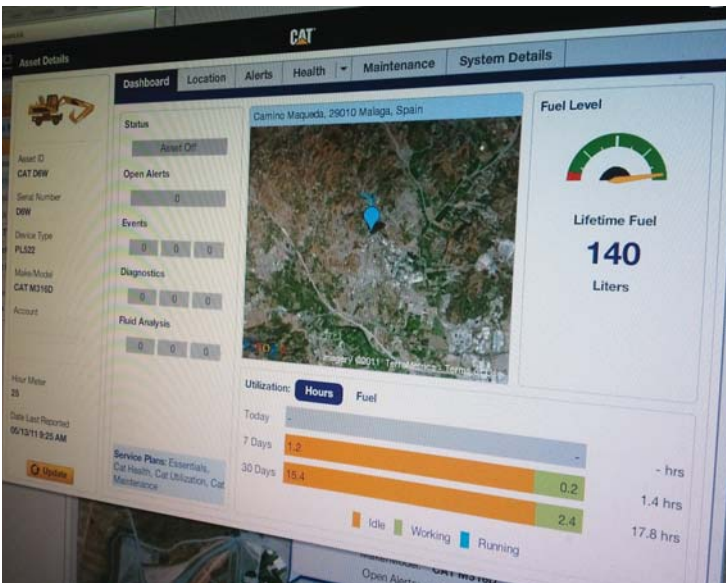

CAT® CONNECT



EQUIPMENT MANAGEMENT



PRODUCTIVITY



SAFETY



SUSTAINABILITY

Safety

Your Safety Is NOT Optional

Cab Ingress

We bring a solution to allow you to safely climb into the cab:

- Three longer access steps, aligned with the cab entry
- Anti-skid plates on all walkways and steps reducing slipping hazards
- Convenient door handrail
- Tiltable console to make sure the way in and out is free of obstacle

Safe and Quiet Cab

The cab provides you with a safe environment. It also contributes to your comfort with limited vibrations and drastically reduced sound levels.





Embedded Features

Smart embedded devices help enforce safe behavior:

- 1) Laminated windshield and skylight window. One-piece 10 mm (0.4") windshield and skylight fulfilling EN356 P5A standards.
- 2) Lowering check valves
- 3) Safety seat belt indicator
- 4) Safety lever
- 5) Emergency shut-off switch
- 6) Automatic brake and axle lock
- 7) Punched, anti-slippery walking surfaces
- 8) Battery disconnect switch
- 9) Swing and implement electronic lock
- 10) Travel alarm
- 11) All doors equipped with gas struts cylinders
- 12) Emergency hammer and exit
- 13) ROPS compliant and front/top guards compatible cab
- 14) Sound proofing
- 15) Beacon available

NEW! Quick coupler control switch, ISO 13031 compliant

Smart Lighting

- LED lights for all working lights for enhanced night-time visibility
- Halogen lights for front roading lights
- LED dome light for better illumination inside the cab
- **NEW!** Dedicated LED lights for both rear and side cameras



Great Views

- Enlarged glass gives you excellent visibility to the front, top, rear, and sides, even to the right
- Standard rearview camera gives you a clear field of view behind the machine
- Standard sideview camera, to check nothing is hidden to you from the front right hand side to the rear of the machine
- **NEW!** Monitor split-screen to easily check cameras rearview and sideview on the same display
- Lenses of all the cameras are wide angle and heated
- All mirrors are wide angle and allow view not only around the machine but also to the ground

Unmatched Visibility

Make Sure Nothing Is Hidden to You

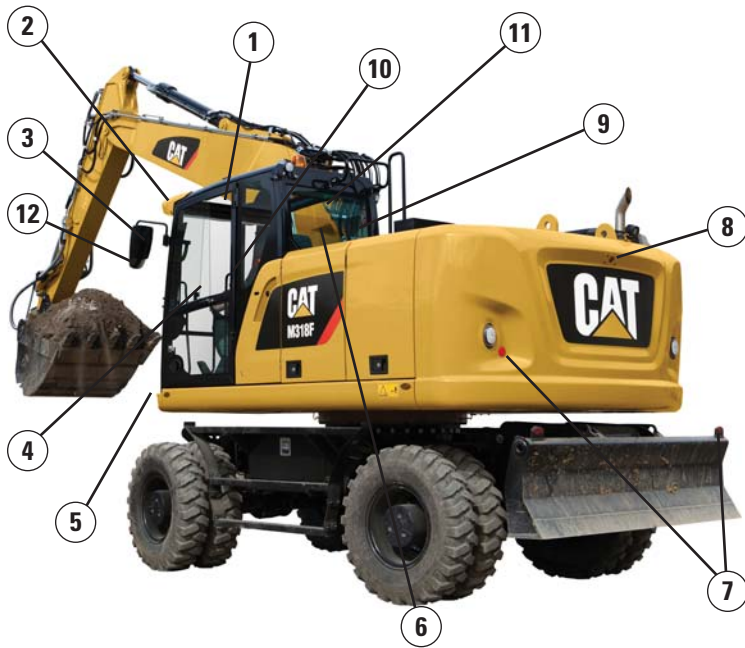

Visibility all around is critical, especially for machines which go on public roads.

- 1) Increased skylight and windshield glass areas
- 2) Improved lighting with standard LED lights for all working lights
- 3) Optional electrically adjustable and heated mirrors
- 4) Great left hand side visibility with all glass door
- 5) Halogen rooding lights
- 6) Wide rear window
- 7) Red reflectors, on counterweight and rear blade/outriggers
- 8) Standard wide rearview camera with LED light
- 9) Standard wide sideview camera with LED light
- 10) Split-screen display of both cameras on the same monitor
- 11) Large right hand side window
- 12) Mirrors, wide angle, with additional lower mirror for ground visibility

Complete Customer Care

Your Cat Dealer Will Support You Like No Other

Support You Can Count On

From helping you to choose the right machine to knowledgeable on-going support, Cat dealers provide the best-in-sales and services.

- **Best long-term investment** with financing options and services
- **Productive operation** with training programs
- **Preventive maintenance** and guaranteed maintenance contracts
- **Uptime**, with best-in-class parts availability
- **Repair, rebuild, or replace?** Your dealer can help evaluate the best option.



M318F Wheeled Excavator Specifications

Engine

Engine Model	Cat C7.1 ACERT ⁽¹⁾	
Ratings	1,750 rpm	
Engine Gross Power (maximum)		
ISO 14396	129.4 kW	174 hp
ISO 14396 (metric)	176 hp	
Net Power (Rated) ⁽²⁾		
ISO 9249/SAE J1349	126 kW	169 hp
ISO 9249/SAE J1349 (metric)	171 hp	
80/1269/EEC	126 kW	169 hp
Net Power (maximum)		
ISO 9249/SAE J1349	126 kW	169 hp
ISO 9249/SAE J1349 (metric)	171 hp	
80/1269/EEC	126 kW	169 hp
Bore	105 mm	4.1 in
Stroke	135 mm	5.3 in
Displacement	7.01 L	427.8 in ³
Maximum Torque at 1,400 rpm	783 N·m	578 lbf-ft
Number of Cylinders	6	

⁽¹⁾ Meets Tier 4 Final/Stage IV emission standards.

⁽²⁾ Rated speed 1,750 rpm. Constant power from 1,500-1,750 rpm.

- Net power advertised is the power available at the flywheel when engine is equipped with air cleaner, CEM exhaust gas aftertreatment, alternator, and cooling fan running at intermediate speed.
- No deratings required up to 3000 m (9,842 ft) altitude. Automatic derating occurs after 3000 m (9,842 ft).

Transmission

Forward/Reverse		
1st Gear	10 kph	6.2 mph
2nd Gear	35 kph	21.7 mph
Creeper Speed		
1st Gear	3 kph	1.9 mph
2nd Gear	12 kph	7.5 mph
Drawbar Pull	103 kN	23,155 lbf
Maximum Gradeability (at 17 500 kg/38,580 lb)	75%	

Service Refill Capacities

Fuel Tank (total capacity)	330 L	87.2 gal
Diesel Exhaust Fluid Tank	34.5 L	9.1 gal
Cooling System	46.9 L	12.4 gal
Engine Crankcase	18.5 L	4.9 gal
Rear Axle Housing (differential)	14 L	3.7 gal
Front Steering Axle (differential)	10.5 L	2.8 gal
Final Drive	2.5 L	0.7 gal
Powershift Transmission	2.5 L	0.7 gal

Swing Mechanism

Maximum Swing Speed	9.7 rpm	
Maximum Swing Torque	42 kN·m	31,233 lbf-ft

Undercarriage

Axle Clearance	360 mm	14.2 in
Maximum Steering Angle	35°	
Oscillation Axle Angle	±9°	
Minimum Turning Radius		
Standard Axle		
Outside of Tire	6400 mm	21.0 ft
End of VA Boom	7000 mm	23.0 ft
End of One-Piece Boom	8300 mm	27.2 ft
Maximum Towable Trailer Mass*	8000 kg	17,637 lb

*Not available in Australia and New Zealand.

Weights

Operating Weights*	17 930 kg-	39,529 lb-
	18 670 kg	41,160 lb

Weights

VA Boom		
Rear Dozer, Front Outriggers	18 410 kg	40,587 lb
Front and Rear Outriggers	18 670 kg	41,160 lb
One-Piece Boom		
Rear Dozer, Front Outriggers	17 930 kg	39,528 lb
Front and Rear Outriggers	18 130 kg	39,970 lb
Sticks**		
Medium, 2400 mm (7'10")	730 kg	1,609 lb
Long, 2600 mm (8'6")	750 kg	1,653 lb
Counterweight		
Standard	3400 kg	7,496 lb
Optional	3900 kg	8,598 lb

*Operating weight includes medium stick, 3400 kg (7,496 lb) counterweight, full fuel tank, operator, 210 kg (463 lb) quick coupler, 600 kg (1,323 lb) bucket and dual pneumatic tires. Weight varies depending on configuration.

**Includes cylinder, bucket linkage, pins and standard hydraulic lines.

M318F Wheeled Excavator Specifications

Hydraulic System

Tank Capacity	122 L	32.2 gal
System	210 L	55.5 gal
Maximum Pressure		
Implement Circuit		
Normal	350 bar	5,076 psi
Heavy Lift	370 bar	5,366 psi
Travel Circuit	350 bar	5,076 psi
Auxiliary Circuit		
High Pressure	350 bar	5,076 psi
Medium Pressure	185 bar	2,683 psi
Swing Mechanism	370 bar	5,366 psi
Maximum Flow		
Implement/Travel Circuit	250 L/min	66 gal/min
Auxiliary Circuit		
High Pressure	250 L/min	66 gal/min
Medium Pressure	49 L/min	12.9 gal/min
Swing Mechanism	84 L/min	22 gal/min

Tires

Standard	10.00-20 (Dual Pneumatic)
Optional	11.00-20 (Dual Pneumatic) 445/70/R19.5 TL XF (Single Pneumatic) 10.00-20 (Dual Solid Rubber)*

*Not available in Australia and New Zealand.

Blade

Blade Type	Parallel	
Width	2550 mm	100.4 in
Blade Roll-Over Height	576 mm	22.7 in
Blade Total Height	680 mm	26.7 in
Maximum Lowering Depth from Ground	131 mm	5 in
Maximum Raising Height above Ground	490 mm	1'7"

Emissions and Safety

Engine Emissions	Tier 4 Final/Stage IV	
Diesel Exhaust Fluid	Must meet ISO 22241	
Fluids (Optional)		
Biodiesel up to B20	Meets EN 14214 or ASTM D6751 with EN590 or ASTM D975 Standard Mineral diesel fuels	
Vibration Levels		
Maximum Hand/Arm		
ISO 5349:2001	<2.5 m/s ²	<8.2 ft/s ²
Maximum Whole Body		
ISO/TR 25398:2006	<0.5 m/s ²	<1.6 ft/s ²
Seat Transmissibility Factor		
ISO 7096:2000-spectral class EM5	<0.7	

Standards

ROPS	ROPS (Rollover Protective Structure) offered by Caterpillar meets ROPS criteria ISO 12117-2:2008	
Operator Protective Structure: Top/Front Guards	FOPS (Falling Object Protective Structure) meets FOPS criteria ISO 10262:1998 and SAE J1356:2008	
Cab/Sound Levels	Meets appropriate standards as listed	

Sound Performance

Operator Sound	
2000/14/EC	71 dB(A)
Spectator Sound	
2000/14/EC	99 dB(A)

- Operator Sound – The operator sound level is measured according to the procedures specified in 2000/14/EC, for a cab offered by Caterpillar, when properly installed and maintained and tested with the door and windows closed.
- Exterior Sound – The labeled spectator sound power level is measured according to the test procedures and conditions specified in 2000/14/EC.
- Hearing protection may be needed when operating with an open operator station and cab (when not properly maintained for doors/windows open) for extended periods or in noisy environment(s).

M318F Wheeled Excavator Specifications

Dimensions

All dimensions are approximate. Values are with 10.00-20 pneumatic tires.

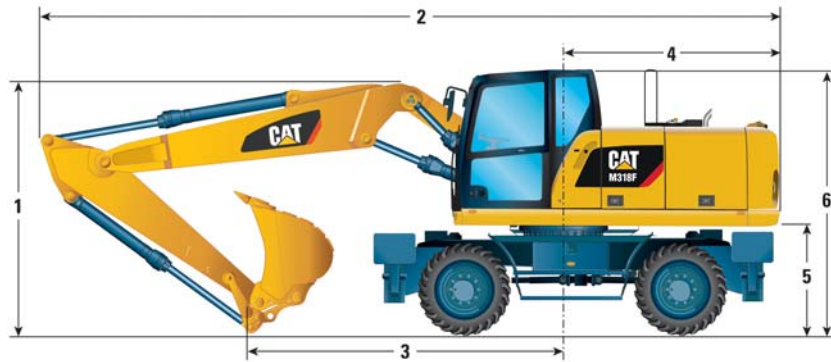

	mm (ft/in)	Variable Adjustable Boom		One-Piece Boom	
		2400 (7'10")	2600 (8'6")	2400 (7'10")	2600 (8'6")
Stick Length	mm (ft/in)	2400 (7'10")	2600 (8'6")	2400 (7'10")	2600 (8'6")
1 Shipping Height with Falling Object Guard and Handrails Lowered (highest point between boom and cab)	mm (ft/in)	3305 (10'10")			
2 Shipping Length	mm (ft/in)	8610 (28'3")	8600 (28'3")	8460 (27'9")	8460 (27'9")
3 Support Point	mm (ft/in)	3650 (12'0")	3550 (11'8")	3270 (10'9")	3150 (10'4")
4 Tail Swing Radius	mm (ft/in)	2300 (7'6")			
5 Counterweight Clearance	mm (ft/in)	1280 (4'2")			
6 Cab Height – No Falling Object Guard, Handrails Lowered	mm (ft/in)	3190 (10'6")			
With Handrails not Lowered	mm (ft/in)	3270 (10'9")			
With Falling Object Guard	mm (ft/in)	3305 (10'10")			
7 Overall Machine Width					
Width with Outriggers on Ground	mm (ft/in)	3680 (12'1")			
Width with Outriggers Up	mm (ft/in)	2550 (8'4")			
Width with Blade	mm (ft/in)	2250 (8'4")			
8 Maximum Outriggers Depth	mm (in)	120 (4.7")			



*Maximum tire clearance with outrigger fully down

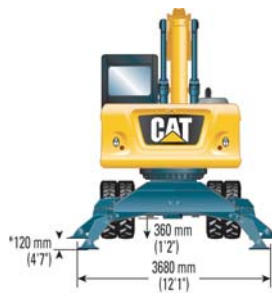

Roading position with both sticks
Maximum boom height in roading position with a VA is below 4 m (13'1")



Undercarriage with 2 sets of outriggers

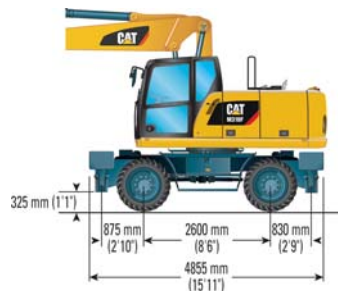

Undercarriage with 1 set of outriggers and dozer

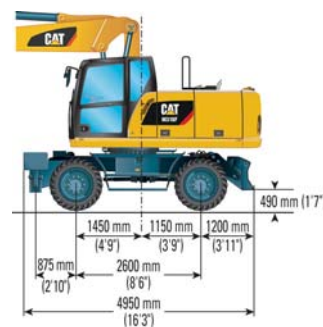

M318F Wheeled Excavator Specifications

Working Ranges

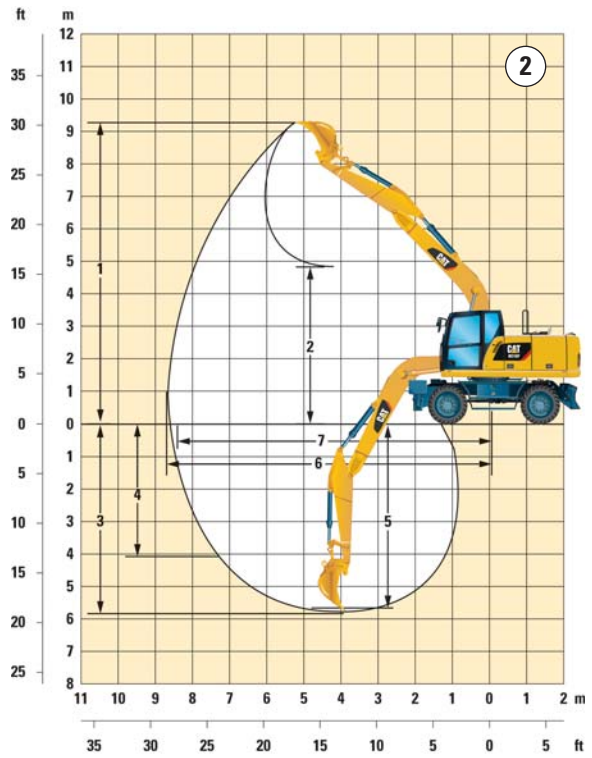
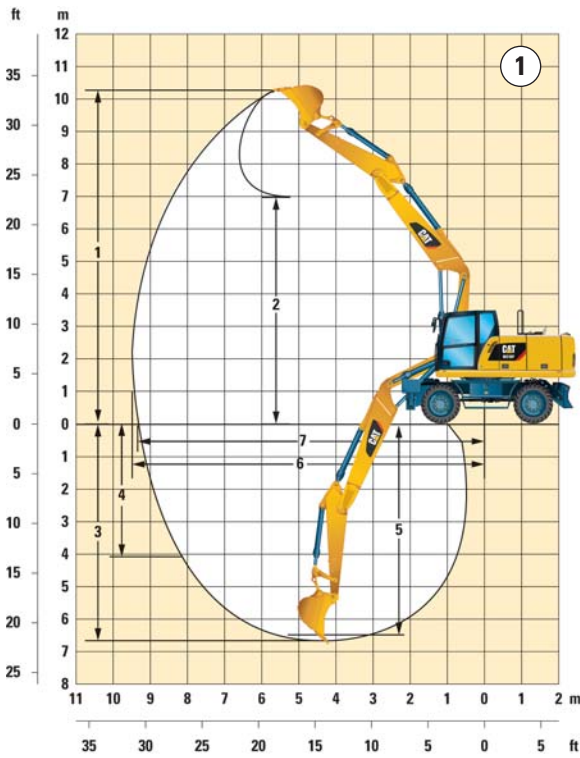

		①		②	
		Variable Adjustable Boom		One-Piece Boom	
Stick Length	mm (ft/in)	2400 (7'10")	2600 (8'6")	2400 (7'10")	2600 (8'6")
1 Digging Height	mm (ft/in)	10 275 (33'9")	10 435 (34'3")	9140 (30'0")	9255 (30'4")
2 Dump Height	mm (ft/in)	7135 (23'5")	7265 (23'10")	6110 (20'1")	6225 (20'5")
3 Digging Depth	mm (ft/in)	5890 (19'4")	6090 (20'0")	5690 (18'8")	5890 (19'4")
4 Vertical Wall Digging Depth	mm (ft/in)	4600 (15'1")	4780 (15'8")	4665 (15'4")	4845 (15'11")
5 Depth 2.5 m (8'2") in Straight Clean-Up	mm (ft/in)	5785 (19'0")	5985 (19'8")	5490 (18'0")	5700 (18'8")
6 Reach	mm (ft/in)	9385 (30'9")	9580 (31'5")	9175 (30'1")	9365 (30'9")
7 Reach at Ground Level	mm (ft/in)	9210 (30'3")	9405 (30'10")	8995 (29'6")	9190 (30'2")
Bucket Forces (ISO 6015)	kN (lbf)	101 (22,705)		101 (22,705)	
Stick Forces (ISO 6015)	kN (lbf)	74 (16,635)	71 (15,961)	74 (16,635)	71 (15,961)

Working range dimensions refer to stick nose pin, with pneumatic tires.

Range values are calculated with GD Bucket, 1200 mm (48 in), 0.91 m³ (1.19 yd³) with tips K080 and quick coupler with a tip radius of 1574 mm (5'2").

Bucket and Stick force values are calculated with heavy lift on (no quick coupler) and a tip radius of 1404 mm (4'7").

M318F Wheeled Excavator Specifications

Bucket Specifications and Compatibility

Contact your Cat dealer for special bucket requirements.

				Variable Adjustable Boom								One-Piece Boom							
Stick Length				2400 mm (7'10")				2600 mm (8'6")				2400 mm (7'10")				2600 mm (8'6")			
	Width	Capacity	Weight	Free on wheels	Dozer lowered	1 set of stabilizers lowered	Fully stabilized	Free on wheels	Dozer lowered	1 set of stabilizers lowered	Fully stabilized	Free on wheels	Dozer lowered	1 set of stabilizers lowered	Fully stabilized	Free on wheels	Dozer lowered	1 set of stabilizers lowered	Fully stabilized
Without Quick Coupler				With 3.4 mt (7,496 lb) Counterweight															
General Duty (GD)	750 (30)	0.49 (0.64)	464 (1,022)																
	1100 (43)	0.79 (1.03)	583 (1,285)																
	1200 (48)	0.91 (1.19)	651 (1,435)																
	1300 (51)	1.00 (1.31)	663 (1,462)																
	1400 (55)	1.09 (1.43)	712 (1,570)																
Heavy Duty (HD)	1300 (51)	1.00 (1.31)	699 (1,541)																
Ditch Cleaning (DC)	2000 (78)	0.54 (0.71)	431 (950)																
Ditch Cleaning Tilt (DCT)	1800 (71)	0.48 (0.63)	567 (1,250)																
	2000 (78)	0.53 (0.69)	597 (1,316)																
With Pin Grabber Coupler				With 3.4 mt (7,496 lb) Counterweight															
General Duty (GD)	750 (30)	0.49 (0.64)	464 (1,022)																
	1100 (43)	0.79 (1.03)	583 (1,285)																
	1200 (48)	0.91 (1.19)	651 (1,435)																
	1300 (51)	1.00 (1.31)	663 (1,462)																
	1400 (55)	1.09 (1.43)	712 (1,570)																
Heavy Duty (HD)	1300 (51)	1.00 (1.31)	699 (1,541)																
Ditch Cleaning (DC)	2000 (78)	0.54 (0.71)	431 (950)																
Ditch Cleaning Tilt (DCT)	1800 (71)	0.48 (0.63)	567 (1,250)																
	2000 (78)	0.53 (0.69)	597 (1,316)																

The above loads are in compliance with hydraulic excavator standard EN474, they do not exceed 87% of hydraulic lifting capacity or 75% of tipping capacity with front linkage fully extended at ground line with bucket curled.

Capacity based on ISO 7451.

Bucket weight with General Duty tips.

- Maximum material density 2100 kg/m³ (3,500 lb/yd³)
- Maximum material density 1800 kg/m³ (3,000 lb/yd³)
- Maximum material density 1500 kg/m³ (2,500 lb/yd³)
- Maximum material density 1200 kg/m³ (2,000 lb/yd³)
- Maximum material density 900 kg/m³ (1,500 lb/yd³)
- Not recommended

Caterpillar recommends using appropriate attachments to maximize the value customers receive from our products. Use of attachments, including buckets, which are outside of Caterpillar's recommendations or specifications for weight, dimensions, flows, pressures, etc. may result in less-than-optimal performance, including but not limited to reductions in production, stability, reliability, and component durability. Improper use of an attachment resulting in sweeping, prying, twisting and/or catching of heavy loads will reduce the life of the boom and stick.

M318F Wheeled Excavator Specifications

Attachments Matching Guide

When choosing between various attachment models that can be installed onto the same machine configuration, consider attachment application, productivity requirements, and durability. Refer to attachment specifications for application recommendations and productivity information.

		(1)		(2)		(3)		(1)		(2)		(3)	
		2400 mm (7'10")	2600 mm (8'6")	2400 mm (7'10")	2600 mm (8'6")	2400 mm (7'10")	2600 mm (8'6")	2400 mm (7'10")	2600 mm (8'6")	2400 mm (7'10")	2600 mm (8'6")	2400 mm (7'10")	2600 mm (8'6")
Stick Length													
Variable Adjustable Boom		With 3.4 mt (7,496 lb) Counterweight						With 3.9 mt (8,598 lb) Counterweight					
Hydraulic Hammer	H110Es/H115Es												
	H120Es												
Demolition and Sorting Grapple	G310B												
	G315B												
Scrap and Demolition Shear	S320B/S325B												
Compactor Plate	CVP75												
Orange Peel Grapple (4 or 5 Tines)	GSH15B 400 L (½ yd³)	These attachments, along with trash grapples, thumbs and rakes are available for the M318F. Consult your Cat dealer for proper match.											
	GSH15B 500 L (⅝ yd³)												
	GSH15B 600 L (¾ yd³)												
	GSH15B 800 L (1 yd³)												
One-Piece Boom		With 3.4 mt (7,496 lb) Counterweight						With 3.9 mt (8,598 lb) Counterweight					
Hydraulic Hammer	H110Es/H115Es												
	H120Es												
Multi-Processor	MP318 CC Jaw												
	MP318 D Jaw												
	MP318 S Jaw												
Crusher	P315												
Pulverizer	P215												
Demolition and Sorting Grapple	G310B												
	G315B												
Scrap and Demolition Shear	S320B/S325B												
Compactor Plate	CVP75												
Pin Grabber Coupler	Cat PG												

(1) Dozer lowered

(2) 2 sets outriggers lowered

(3) Dozer and outrigger lowered

 Attachment is a match

 Pin-on only

 Over the front only

 Boom Mount

 Over the front only with Pin Grabber coupler

 Not recommended

Offerings not available in all areas. Matches are dependent on Wheeled Excavator configurations. Consult your Cat dealer to determine what is offered in your area and for proper attachment match.

M318F Wheeled Excavator Specifications

Lift Capacities – Variable Adjustable Boom

All values are in kg, bucket cylinder and bucket linkage installed, attachment: none, with counterweight (3900 kg), heavy lift on.

Long Stick 2600 mm	Load at maximum reach (stick nose/bucket pin)	Load over front	Load over rear	Load over side	Load point height	Undercarriage configuration												mm
						3000 mm			4500 mm			6000 mm			7500 mm			
						Load over front	Load over rear	Load over side	Load over front	Load over rear	Load over side	Load over front	Load over rear	Load over side	Load over front	Load over rear	Load over side	
6000 mm	Rear dozer up					*4900	*4900	4800	*4750	3450	3000				*3000	2800	2450	6740
	Rear dozer down					*4900	*4900	4900	*4750	3400					*3000	*3000	2800	
	Dozer and stabilizer down					*4900	*4900	4900	*4750	*4750					*3000	*3000	*3000	
	2 sets of stabilizers down					*4900	*4900	4900	*4750	*4750					*3000	*3000	*3000	
4500 mm	Rear dozer up					*5800	5250	4550	4750	3350	2950	*2900	2300	2000	*2800	2300	2000	7510
	Rear dozer down					*5800	5250	4550	*4900	3350	*2900	2300	2300	*2800	2300	2000		
	Dozer and stabilizer down					*5800	*5800	*5800	*4900	*4900	*2900	*2900	*2900	*2800	*2800	*2800		
	2 sets of stabilizers down					*5800	*5800	*5800	*4900	*4900	*2900	*2900	*2900	*2800	*2800	*2800		
3000 mm	Rear dozer up					*7150	4900	4200	4600	3200	2800	3250	2250	1950	*2800	2050	1800	7910
	Rear dozer down					*7150	4850		*5200	3200		*4150	2250	*2800	2050			
	Dozer and stabilizer down					*7150	*7150		*5200	4800		*4150	3400	*2800	*2800			
	2 sets of stabilizers down					*7150	*7150		*5200	*5200		*4150	3950	*2800	*2800			
1500 mm	Rear dozer up					6750	4550	3850	4400	3050	2600	3200	2200	1900	2900	2000	1700	8000
	Rear dozer down					*8550	4500		*5650	3050		*4350	2200	*2900	2000			
	Dozer and stabilizer down					*8550	7100		*5650	4650		*4350	3350	*2900	*2900			
	2 sets of stabilizers down					*8550	*8550	8450	*5650	*5650	5400	*4350	*4350	3900	*2900	*2900		
0 mm	Rear dozer up					6550	4350	3700	4300	2900	2500	3150	2150	1850	3000	2050	1750	7800
	Rear dozer down					*8650	4300		*6200	2900		*4650	2150	*3200	2050			
	Dozer and stabilizer down					*8650	6900		*6200	4500		*4650	3300	*3200	3100			
	2 sets of stabilizers down					*8650	*8650	8200	*6200	*6200	5300	*4650	*4650	3850	*3200	*3200		
-1500 mm	Rear dozer up	*6850	*6850	6600	6500	4300	3650	4250	2850	2450				3300	2250	1950	7270	
	Rear dozer down	*6850	*6850		*7850	4250		*5750	2850					*3700	2250			
	Dozer and stabilizer down	*6850	*6850		*7850	6850		*5750	4450					*3700	3450			
	2 sets of stabilizers down	*6850	*6850		*7850	*7850		*5750	5250					*3700	*3700			
-3000 mm	Rear dozer up					*6100	4350	3700	*4200	2950	2500			*3550	2750	2350	6330	
	Rear dozer down					*6100	4300		*4200	2950				*3550	2750			
	Dozer and stabilizer down					*6100	*6100		*4200	*4200				*3550	*3550			
	2 sets of stabilizers down					*6100	*6100		*4200	*4200				*3550	*3550			

*Limited by hydraulic rather than tipping load.

Lift capacity ratings are based on ISO 10567:2007, they do not exceed 87% of hydraulic lifting capacity or 75% of tipping load. The load point is the center line of the bucket pivot mounting pin on the stick. The oscillating axle must be locked. Lifting capacities are based on the machine standing on a firm uniform supporting surface and the Variable Boom Cylinder adjusted to the maximum length. For lifting capacity including bucket and/or quick coupler, the respective weight has to be subtracted from above values. The use of a work tool attachment point to handle/lift objects, could affect the machine lift performance.

Always refer to the appropriate Operation and Maintenance Manual for specific product information.

M318F Wheeled Excavator Specifications

Lift Capacities – One-Piece Boom

All values are in lb, bucket cylinder and bucket linkage installed, attachment: none, with counterweight (8,598 lb), heavy lift on.

Long Stick 8'6"	Undercarriage configuration	Load at maximum reach (stick nose/bucket pin)			Load over front			Load over rear			Load over side			Load point height			ft			
		5 ft			10 ft			15 ft			20 ft			25 ft						
		Stick	Quick Coupler	Bucket	Stick	Quick Coupler	Bucket	Stick	Quick Coupler	Bucket	Stick	Quick Coupler	Bucket	Stick	Quick Coupler	Bucket				
25 ft	Rear dozer up																*7,600	*7,600	*7,600	16.34
	Rear dozer down																*7,600	*7,600	*7,600	
	Dozer and stabilizer down 2 sets of stabilizers down																*7,600	*7,600	*7,600	
20 ft	Rear dozer up																*6,500	*6,500	*6,500	21.06
	Rear dozer down																*6,500	*6,500	*6,500	
	Dozer and stabilizer down 2 sets of stabilizers down																*6,500	*6,500	*6,500	
15 ft	Rear dozer up																*6,500	*6,500	*6,500	23.79
	Rear dozer down																*6,500	*6,500	*6,500	
	Dozer and stabilizer down 2 sets of stabilizers down																*6,500	*6,500	*6,500	
10 ft	Rear dozer up																*6,200	*6,200	*6,200	25.20
	Rear dozer down																*6,200	*6,200	*6,200	
	Dozer and stabilizer down 2 sets of stabilizers down																*6,200	*6,200	*6,200	
5 ft	Rear dozer up																*6,200	*6,200	*6,200	25.56
	Rear dozer down																*6,200	*6,200	*6,200	
	Dozer and stabilizer down 2 sets of stabilizers down																*6,200	*6,200	*6,200	
0 ft	Rear dozer up																*6,200	*6,200	*6,200	24.87
	Rear dozer down																*6,200	*6,200	*6,200	
	Dozer and stabilizer down 2 sets of stabilizers down																*6,200	*6,200	*6,200	
-5 ft	Rear dozer up																*6,200	*6,200	*6,200	23.03
	Rear dozer down																*6,200	*6,200	*6,200	
	Dozer and stabilizer down 2 sets of stabilizers down																*6,200	*6,200	*6,200	
-10 ft	Rear dozer up																*6,200	*6,200	*6,200	19.75
	Rear dozer down																*6,200	*6,200	*6,200	
	Dozer and stabilizer down 2 sets of stabilizers down																*6,200	*6,200	*6,200	

*Limited by hydraulic rather than tipping load.

Lift capacity ratings are based on ISO 10567:2007, they do not exceed 87% of hydraulic lifting capacity or 75% of tipping load. The load point is the center line of the bucket pivot mounting pin on the stick. The oscillating axle must be locked. Lifting capacities are based on the machine standing on a firm uniform supporting surface. For lifting capacity including bucket and/or quick coupler, the respective weight has to be subtracted from above values. The use of a work tool attachment point to handle/lift objects, could affect the machine lift performance.

Always refer to the appropriate Operation and Maintenance Manual for specific product information.

Standard Equipment

Standard equipment may vary. Consult your Cat dealer for details.

ELECTRICAL

- Alternator, 115A
- Lighting
 - LED light package, including all working lights (compatible with falling object guard). Working lights include cab mounted lights (two front, one rear), one on the counterweight for the rear camera and one on the right for the sideview camera.
 - Boom LED working light
 - Cab interior LED light
 - Rooding lights two front, halogen
 - Rooding lights two rear, LED modules
- Main shut-off switch
- Maintenance free batteries, heavy duty
- Signal/warning horn
- Electrical refueling pump

ENGINE

- Cat C7.1 engine with ACERT Technology meets Tier 4 Final/Stage IV emission standards
- Aftertreatment technologies including the Cat Clean Emission Module package (CEM)
- Automatic Engine Speed Control (AESC), including one touch low idle
- Engine Idle Shutdown (EIS)
- Power mode selector
- Altitude 3000 m (9,842 ft) capability without de-rate
- Automatic starting aid
- Fuel/water separator with water in fuel switch
- Electric fuel priming pump

HYDRAULICS

- Adjustable hydraulic sensitivity
- All Cat XT™-6 ES hoses
- Anti-drift valves for bucket, and tool control/multi-function circuits
- Auxiliary boom and stick lines
- Basic control circuits
 - Medium pressure
 - Two-way, medium pressure circuit, for rotating or tilting of attachments
 - Tool control/multi function
 - One/two-way high pressure for hammer application or opening and closing of attachments
 - Programmable flow and pressure for up to 10 attachments – selection via monitor
 - Quick coupler circuit and lines for hydraulic quick coupler (either Pin Grabber or dedicated/CW Quick Couplers, controlled by a dedicated switch)
- Boom Lowering Check Valve (BLCV), including overload warning device
- Electric Pump Control (EPC)
- Heavy lift mode
- Load-sensing hydraulic system
- Separate swing pump
- Stick Lowering Check Valve (SLCV)
- Stick regeneration circuit

(continued on next page)

M318F Standard Equipment

Standard Equipment *(continued)*

Standard equipment may vary. Consult your Cat dealer for details.

OPERATOR STATION

- Reinforced (ROPS) cab structure compliant with 2006/42/EC and tested according to ISO 12117-2:2008
- Adjustable armrests
- Air conditioner, heater and defroster with automatic climate control
- Cigarette lighter (24 volt)
- Beverage cup/can holder
- Bolt-on Falling Object Guards (FOGS) capability
- Bottle holder
- Bottom mounted intermittent (four speeds) wiping system that covers the upper and lower windshield glass
- Cameras
 - Rear mounted wide angle camera (integrated into the counterweight)
 - Right side wide angle camera, mounted on the cooling hood
 - Both cameras are displayed side by side on a dedicated large color monitor
- Coat hook
- Cruise Control System
- Fastened seat belt warning signal
- Floor mat, washable, with storage compartment
- FM Radio with CD player, speakers and USB port
- Fully adjustable suspension seat
- Instrument panel and full graphic and color display
 - Information and warning messages in local language
 - Gauges for fuel level, engine coolant, Diesel Exhaust Fluid (DEF) and hydraulic oil temperature
 - Filters/fluids change intervals
 - Indicators for headlights, turning signal, low fuel, engine dial setting
 - Clock with 10-day backup battery
- Interior LED lighting with door switch
- Joystick pilot operated with one proportional slider
- Joystick pattern, changeable
- Laminated upper front windshield
- Left side console, tiltable, with lock out for all controls
- Literature holder in right hand side panel
- Mobile phone holder
- Parking brake
- Pin-code, engine start prevention
- Power supply, 12V-10A
- Rain protector*
- Rear window (tempered glass)/emergency exit, with hammer
- Retractable seat belt, integrated into the seat
- Safety lever, integrated into the left console
- Skylight, laminated glass
- Sealed cab with positive filtered ventilation
- Sliding door windows
- Steering column, adjustable height and angle
- Storage area suitable for a lunch box
- Sunshade for windshield and skylight

UNDERCARRIAGE

- All wheel drive
- Automatic brake/axle lock
- Creeper speed
- Electronic swing and travel lock
- Heavy-duty axles, advanced disc brake system and travel motor, adjustable braking force
- Oscillating front axle, lockable, with remote greasing point
- Steps with box in undercarriage (left and right)
- Two-piece drive shaft, with 1,000 hours greasing intervals
- Two speed hydrostatic transmission
- Spacer rings for tires

OTHER EQUIPMENT

- Auto-lube, centralized greasing (implement and swing gear)
- Automatic swing brake
- Counterweight, 3400 kg (7,496 lb)
- Engine emergency shutoff switch
- Mirrors, wide angle, frame and cab
- Product Link
- S•O•SSM sampling valves for engine oil, hydraulic oil and coolant
- Bucket linkage for digging sticks

*Not compatible with the falling objects guards

Optional Equipment

Optional equipment may vary. Consult your Cat dealer for details.

AUXILIARY CONTROLS AND LINES

- Basic control circuits
 - Second high pressure
 - Additional two-way, high pressure circuit, for tools requiring a second high or medium pressure function
- SmartBoom

FRONT LINKAGE

- Booms
 - One-piece boom, 5050 mm (16'6")
 - VA boom (two piece), 5200 mm (17'1")
- Sticks
 - 2400 mm (7'10")
 - 2600 mm (8'6")

ELECTRICAL

- Rotating beacon on cab
- Travel alarm

OPERATOR STATION

- Advanced joysticks with two proportional sliders
- Joystick steering
- Seat, adjustable high-back, with vertical and horizontal air-suspension and head rest
 - Comfort, automatic weight adjustment, mechanical lumbar support, heated
 - Deluxe seat adds automatic height and weight adjustment, pneumatic lumbar support, premium fabric, heated and ventilated
- Windshield
 - One-piece impact resistant, laminated windshield and skylight (EN356 P5A standards)
 - 70/30 split, openable
- Mirrors electrically adjustable and heated, frame and cab
- High pressure auxiliary pedal
- Falling Objects Guards (top and front)

UNDERCARRIAGE

- Front blade (parallel)/rear outriggers
- Front blade (parallel)/rear outriggers, with trailer-ready package*
- Front outriggers/rear blade (parallel)
- Front and rear outriggers

OTHER EQUIPMENT

- Cat Machine Security System (MSS)
- Cooling Protection Package for dusty applications (includes fine mesh for enhanced radiator protection and engine air precleaner)*
- Kit, Cooling Protection Package*
- Counterweight, 3900 kg (8,598 lb)
- Fenders, front and rear
- Ride Control
- Tires (see pg. 22)
- Attachments (see pg. 25-26)
- Tilt-Rotator-Ready Package

*Not available in Australia and New Zealand

For more complete information on Cat products, dealer services, and industry solutions, visit us on the web at www.cat.com

© 2016 Caterpillar
All rights reserved

Materials and specifications are subject to change without notice. Featured machines in photos may include additional equipment. See your Cat dealer for available options.

CAT, CATERPILLAR, SAFETY.CAT.COM, their respective logos, "Caterpillar Yellow" and the "Power Edge" trade dress, as well as corporate and product identity used herein, are trademarks of Caterpillar and may not be used without permission.

VisionLink is a trademark of Trimble Navigation Limited, registered in the United States and in other countries.

AEHQ7964
(Americas North,
Australia, New Zealand)

